

REGAL
DESIGN STUDIO RES
2014



Divano trasformabile in letto. Struttura metallica portante con inserti in legno rivestiti in poliuretano espanso. Seduta in poliuretano espanso D30/D35 rivestito con vellutino trapuntato. Schienali rivestiti in poliuretano espanso D21 rivestito con vellutino 2,50 mm. Rete a doghe. Materasso SIMMONS a molle, lungo 195 cm ed alto 18 cm. Piedini quadrati in legno, disponibili nella tinta Noce o Wengè. Divano completamente smontabile. Ingombro massimo con letto aperto cm 225 cm.

Sofabed. Metal structure with wooden inserts coated with polyurethane foam. Seat cushion made of D30/D35 polyurethane foam coated with polyester layer. Back cushions made of D21 polyurethane covered with quilted velvet. Wooden slats spring. Orthopedic coil spring cm 18 thick and cm 195 long. Square wooden feet in walnut and wenge finish. K.D. model, (sofa can be totally disassembled on need). When opened, total depth cm 225.

REGAL
DESIGN STUDIO RES
2014

RGL006 sofa 180
RGL001 sofa 180 bed 115

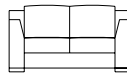

180
70 7/8"

RGL007 sofa 200
RGL002 sofa 200 bed 140

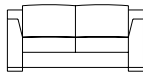

200
78 3/4"

RGL008 sofa 220
RGL003 sofa 220 bed 160

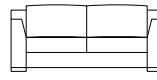

220
86 5/8"

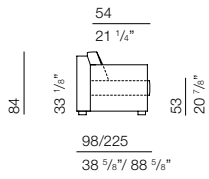

larghezza bracciolo 20 cm
armrest width 7 7/8"

RGL009
ottoman 90x90



90
35 3/8"

RGL010
ottoman with storage 90x90



90
35 3/8"

REGAL

DESIGN STUDIO RES
2014

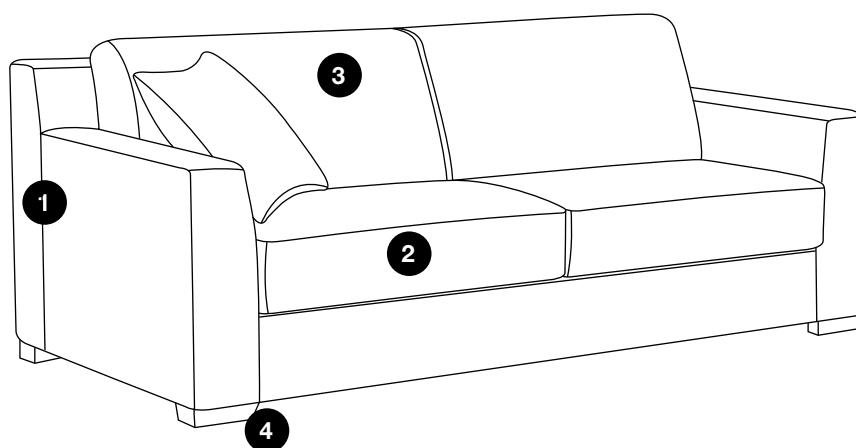

MATERIALI IMPIEGATI

1 STRUTTURA
Legno rivestita in poliuretano espanso
2 SEDUTA
Poliuretano espanso D30\35
3 SCHIENALI
Poliuretano espanso D21

USED MATERIALS

1 STRUCTURE
Wood covered in polyurethane foam
2 SEATS
D30\35 polyurethane foam
3 BACKRESTS
D21 polyurethane foam

FINITURE

4 PIEDI
Legno finitura Wengè
Legno finitura Noce

FINISHES

4 FEET
Wooden Feet Wengè finish
Wooden Feet Walnut finish

SISTEMA DI APERTURA









01

OPENING SYSTEM

01



REGAL
DESIGN STUDIO RES
2014

		ALBERTONE	ALL-IN	BEDFORD	GEORGE	JIMMY	JOAO	MAESTRO	MAGNUM	ESTRAIBILE NIGHT&DAY	NIGHT&DAY SOFABED	NIGHT&DAY BED	NIGHT&DAY MERIDIENNE	PRINCE	REGAL	RICHARD	ROCK1	ROMEO	SWING	VALENTINO
		•	•	•		•			•		•	•	•		•	•				
					•		•	•		•				•			•	•	•	•
	H 12																		•	•
	H 13	•	•	•	•	•	•	•			•			•		•		•		
	H 18								•						•					
	H 12																•			
	H 13	•	•	•	•	•	•	•			•			•		•		•		
	H 14									•		•	•							
			•			•	•	•								•			•	
	01	•	•	•		•	•	•	•		•			•	•	•		•		
	02																		•	•
	03				•															
	04																•			
	05											•	•							
		•	•	•	•	•	•	•	•		•	•	•	•	•	•		•	•	
				•		•	•	•						•		•				

 RETE A DOGHE
WOODEN SLATS

 SISTEMA DI APERTURA
OPENING SYSTEM

 MATERASSO A MOLLE
COIL SPRING MATTRESS

 SMONTABILE
CAN BE TAKE-DOWN

 RETE ELETTRORISALDATA
WELDMESH SPRING

 COMPONIBILE
MODULAR

 MATERASSO IN ESPANSO
FOAM MATTRESS

 PORTAGUANCIALE
PILLOW STORAGE UNIT

NOTE INFORMATIVE

Per un corretto funzionamento della meccanica divano-letto, NON lasciare lenzuola e/o coperte all'interno una volta chiuso il divano.

MANUTENZIONE ORDINARIA DI UN DIVANO RIVESTITO IN TESSUTO

- I rivestimenti possono presentare variazioni di tonalità da una partita all'altra.
- Evitare l'esposizione del prodotto alla luce solare diretta, soprattutto se questa è filtrata da vetrata.
- Tutti i rivestimenti sfoderabili richiedono periodicamente il ripristino delle tensioni iniziali regolando le parti velcrate.
- Per i rivestimenti sfoderabili, attenersi scrupolosamente alle modalità di lavaggio riportate sul cartoncino posto sul prodotto.

MANUTENZIONE ORDINARIA DI UN DIVANO RIVESTITO IN PELLE

- Evitare l'esposizione del prodotto alla luce solare diretta, soprattutto se questa è filtrata da vetrata.
- Evitare di posizionare il prodotto in prossimità di fonti di calore dirette quali camini, stufe, termosifoni.
- Per liberare i pori della pelle dalla polvere che si deposita, utilizzare un panno umido ben strizzato da usare con delicatezza. Ciò vale soprattutto per le tipologie "Naturale", che non sono trattate con alcun prodotto coprente, pertanto sono più delicate.
- Per la pulizia ordinaria delle pelli tipo "Extra" e "Scozia" si può ricorrere a prodotti specifici in commercio, seguendo le istruzioni date dal produttore.
- In caso di macchie accidentali suggeriamo di tamponare immediatamente con carta assorbente sempre evitando di strofinare, ma limitandosi ad asciugare il liquido. La buona riuscita dell'operazione dipende in gran parte dalla tempestività dell'intervento oltre che dall'origine della macchia.
- Non usare mai alcool o solventi, che danneggerebbero definitivamente i rivestimenti.

INFORMATIONS

For the correct working of the spring, please remove all the sheets from the mattress when closing the bed

ROUTINE MAINTENANCE OF A SOFA WITH FABRIC COVERS

- The covers may vary in nuances from one batch to another.
- Avoid exposing the product to direct sunlight, particularly if it is filtered through glass.
- All removable covers regularly require the initial tautness to be restored, adjusting the parts with velcro.
- For all removable covers, please follow the washing instructions on the tag stitched on the product.

ROUTINE MAINTENANCE OF A SOFA UPHOLSTERED IN LEATHER

- Avoid exposing the product to direct sunlight, particularly if it is filtered through glass.
- Do not position the product near sources of direct heat such as fireplaces, stoves or radiators.
- To free the pores of the leather from the dust that has collected, use with care a wet cloth that has been wrung out. This applies above all to the "Naturale" types which are not treated and therefore more delicate.
- For routine cleaning of the "Extra" and "Scozia" leather use can be made of specific products available on the market, following the manufacturer's instructions.
- In the event of accidental staining we recommend blotting the stain immediately with absorbent paper, never rubbing but instead only drying the liquid. The success of the operation mostly depends on prompt action and the origin of the stain.
- Never use alcohol or solvents which alter permanently the upholstery.