

**VALENTINO**

DESIGN DANILO BONFANTI  
1994



Divano trasformabile in letto. Struttura in legno rivestita in poliuretano espanso a quote differenziate. Sedute in poliuretano espanso D30 + falde di dacron + tela di cotone. Rete elettrosaldata. Materasso a molle lunghezza cm 190 e cm 12. Ingombro totale divano letto aperto cm 231.

Sofabed. Wooden structure padded with polyurethane with different space weight. Seat cushions made of D30 polyurethane foam + dacron layers + Cotton lining. Weld mesh spring,, Orthopedic coil spring mattress cm 12 thick and cm 190 long. When opened, total depth cm 231.

**VALENTINO**  
 DESIGN DANILO BONFANTI  
 1994

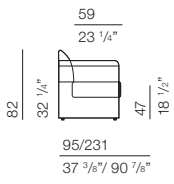

larghezza bracciolo 15 cm  
 arm width 5 7/8"

**34001**  
*armchair 90*



90  
 35 3/8"

**34003 sofa 162**  
**VA004 sofa 162 bed 115**



162  
 63 3/4"

**34005 sofa 192**  
**VA006 sofa 192 bed 145**

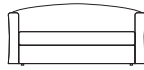

192  
 75 5/8"

**34007 sofa 206**  
**VA008 sofa 206 bed 160**

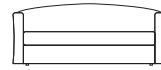

206  
 81 1/8"

## VALENTINO

DESIGN DANILO BONFANTI  
1994

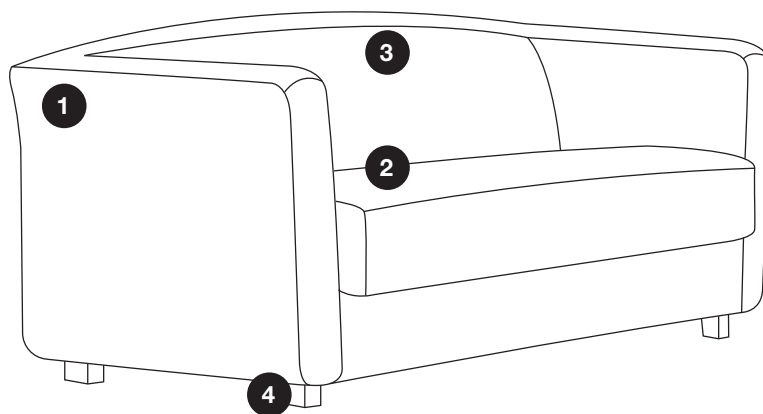

### MATERIALI IMPIEGATI

1 STRUTTURA  
Legno rivestita in poliuretano espanso  
2 SEDUTA  
Poliuretano D30  
3 SCHIENALI  
Poliuretano D30

### USED MATERIALS

1 STRUCTURE  
Wooden covered in polyurethane foam  
2 SEATS  
D30 polyurethane foam  
3 BACKRESTS  
D30 polyurethane foam

### FINITURE

4 PIEDI  
Legno finitura Noce  
Legno finitura Wengè

### FINISHES

4 FEET  
Wooden feet Walnut finish  
Wooden feet Wengè finish

### SISTEMA DI APERTURA









02

### OPENING SYSTEM

02



**VALENTINO**  
DESIGN DANILO BONFANTI  
1994

		ALBERTONE	ALL-IN	BEDFORD	GEORGE	JIMMY	JOAO	MAESTRO	MAGNUM	ESTRAIBILE NIGHT&DAY	NIGHT&DAY SOFABED	NIGHT&DAY BED	NIGHT&DAY MERIDIENNE	PRINCE	REGAL	RICHARD	ROCK1	ROMEO	SWING	VALENTINO
		•	•	•		•			•		•	•	•		•	•				
					•		•	•		•				•			•	•	•	•
	H 12																		•	•
	H 13	•	•	•	•	•	•	•			•			•		•		•		
	H 18								•						•					
	H 12																•			
	H 13	•	•	•	•	•	•	•			•			•		•		•		
	H 14									•		•	•							
			•			•	•	•								•			•	
	01	•	•	•		•	•	•	•		•			•	•	•		•		
	02																		•	•
	03				•															
	04																•			
	05											•	•							
		•	•	•	•	•	•	•	•		•	•	•	•	•	•		•	•	
				•		•	•	•						•		•				

 RETE A DOGHE  
WOODEN SLATS

 SISTEMA DI APERTURA  
OPENING SYSTEM

 MATERASSO A MOLLE  
COIL SPRING MATTRESS

 SMONTABILE  
CAN BE TAKE-DOWN

 RETE ELETTRORISALDATA  
WELDMESH SPRING

 COMPONIBILE  
MODULAR

 MATERASSO IN ESPANSO  
FOAM MATTRESS

 PORTAGUANCIALE  
PILLOW STORAGE UNIT

**VALENTINO**  
DESIGN DANILO BONFANTI  
1994

#### **NOTE INFORMATIVE**

- Per un corretto funzionamento della meccanica divano-letto, NON lasciare lenzuola e/o coperte all'interno una volta chiuso il divano.

#### **MANUTENZIONE ORDINARIA DI UN DIVANO RIVESTITO IN TESSUTO**

- I rivestimenti possono presentare variazioni di tonalità da una partita all'altra.
- Evitare l'esposizione del prodotto alla luce solare diretta, soprattutto se questa è filtrata da vetrata.
- Tutti i rivestimenti sfoderabili richiedono periodicamente il ripristino delle tensioni iniziali regolando le parti velcrate.
- Per i rivestimenti sfoderabili, attenersi scrupolosamente alle modalità di lavaggio riportate sul cartoncino posto sul prodotto.

#### **MANUTENZIONE ORDINARIA DI UN DIVANO RIVESTITO IN PELLE**

- Evitare l'esposizione del prodotto alla luce solare diretta, soprattutto se questa è filtrata da vetrata.
- Evitare di posizionare il prodotto in prossimità di fonti di calore dirette quali camini, stufe, termosifoni.
- Per liberare i pori della pelle dalla polvere che si deposita, utilizzare un panno umido ben strizzato da usare con delicatezza. Ciò vale soprattutto per le tipologie "Naturale", che non sono trattate con alcun prodotto coprente, pertanto sono più delicate.
- Per la pulizia ordinaria delle pelli tipo "Extra" e "Scozia" si può ricorrere a prodotti specifici in commercio, seguendo le istruzioni date dal produttore.
- In caso di macchie accidentali suggeriamo di tamponare immediatamente con carta assorbente sempre evitando di strofinare, ma limitandosi ad asciugare il liquido. La buona riuscita dell'operazione dipende in gran parte dalla tempestività dell'intervento oltre che dall'origine della macchia.
- Non usare mai alcool o solventi, che danneggerebbero definitivamente i rivestimenti.

#### **INFORMATIONS**

- For the correct working of the spring, please remove all the sheets from the mattress when closing the bed

#### **ROUTINE MAINTENANCE OF A SOFA WITH FABRIC COVERS**

- The covers may vary in nuances from one batch to another.
- Avoid exposing the product to direct sunlight, particularly if it is filtered through glass.
- All removable covers regularly require the initial tautness to be restored, adjusting the parts with velcro.
- For all removable covers, please follow the washing instructions on the tag stitched on the product.

#### **ROUTINE MAINTENANCE OF A SOFA UPHOLSTERED IN LEATHER**

- Avoid exposing the product to direct sunlight, particularly if it is filtered through glass.
- Do not position the product near sources of direct heat such as fireplaces, stoves or radiators.
- To free the pores of the leather from the dust that has collected, use with care a wet cloth that has been wrung out. This applies above all to the "Naturale" types which are not treated and therefore more delicate.
- For routine cleaning of the "Extra" and "Scozia" leather use can be made of specific products available on the market, following the manufacturer's instructions.
- In the event of accidental staining we recommend blotting the stain immediately with absorbent paper, never rubbing but instead only drying the liquid. The success of the operation mostly depends on prompt action and the origin of the stain.
- Never use alcohol or solvents which alter permanently the upholstery.